



INSTALLATION INSTRUCTIONS

Accessory

FRONT FENDER PANEL
P/N 08F79-MKJ-D00

Application

CB1000RA

Publication No.

MII

Issue Date

December 2017

Honda Dealer: Please give a copy of these instructions to your customer.

PARTS LIST

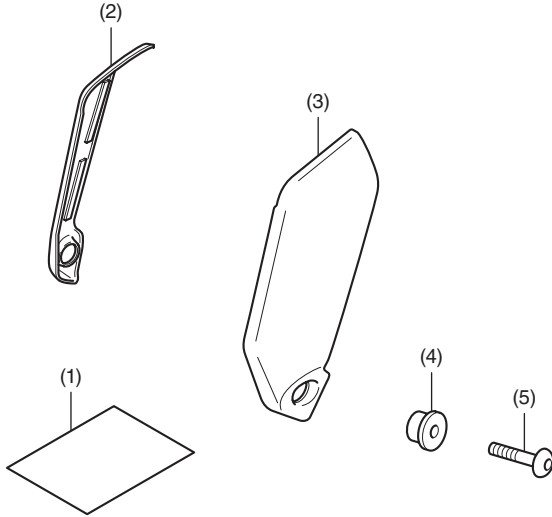

No.	Description	Qty
(1)	URL paper	1
(2)	Right front fender panel	1
(3)	Left front fender panel	1
(4)	Collar	2
(5)	6 mm bolt	2

TOOLS AND SUPPLIES REQUIRED

- Hex wrench (5 mm)
- Isopropyl alcohol
- Shop towel
- Torque wrench

TORQUE CHART

Tighten all screws, bolts, and nuts to their specified torque values. Refer to the Service Manual for the torque values of the removed parts.

Item	N·m	kgf·m	lbf·ft
6 mm bolt	12	1.2	9

INSTALLATION

▲ CAUTION

- To prevent burns, allow the engine, exhaust system, radiator, etc., to cool before installing the accessory.

NOTE:

- Heat the bonding surfaces with a hair dryer if the ambient air temperature is below 70°F (21°C).
- The adhesive reaches full strength in 72 hours. Wait at least 24 hours before riding your motorcycle.

- Remove the bolt as shown.

<Left side>

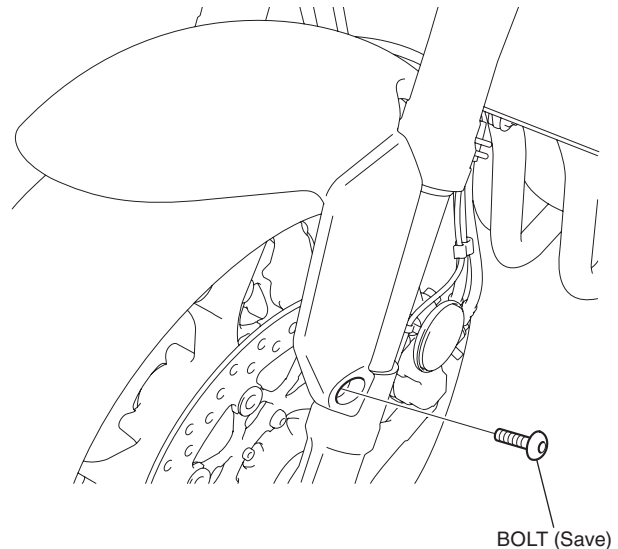

- Clean the surface of the area shown using an isopropyl alcohol.

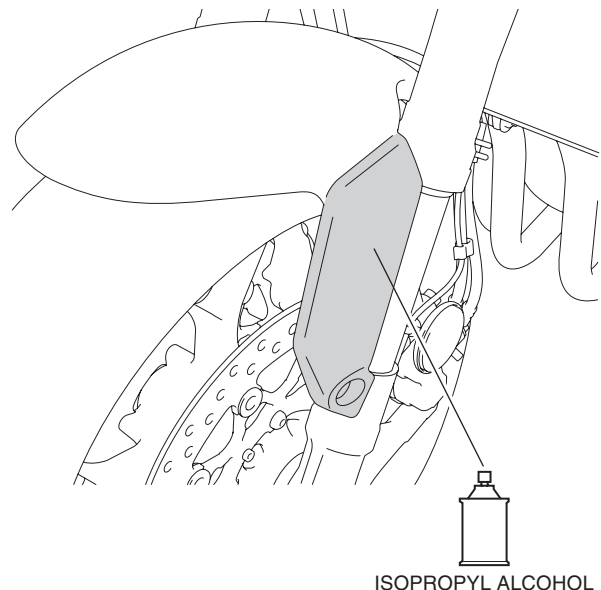

3. Peel off the adhesive backing on the left front fender panel as shown.

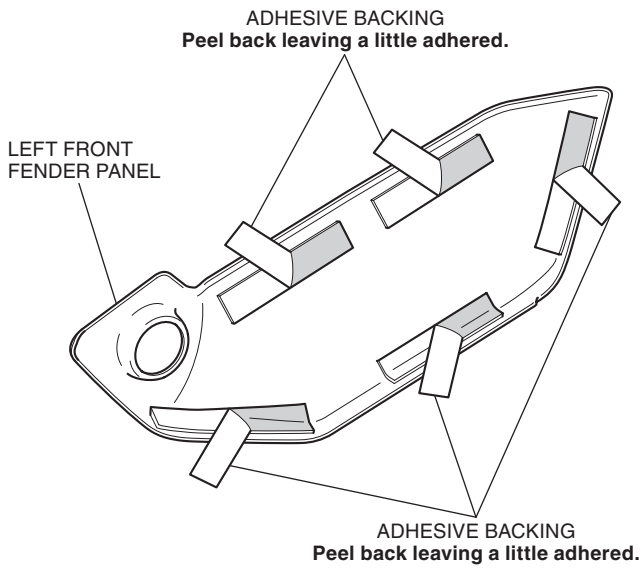

4. Attach the left front fender panel as shown.

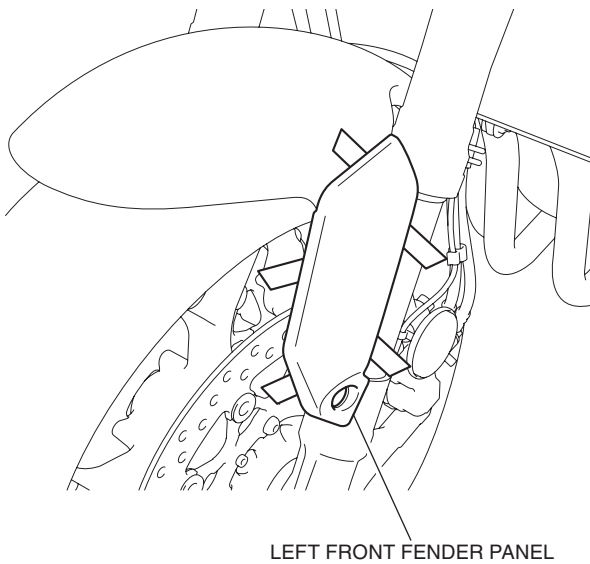

5. Remove the adhesive backing as shown.

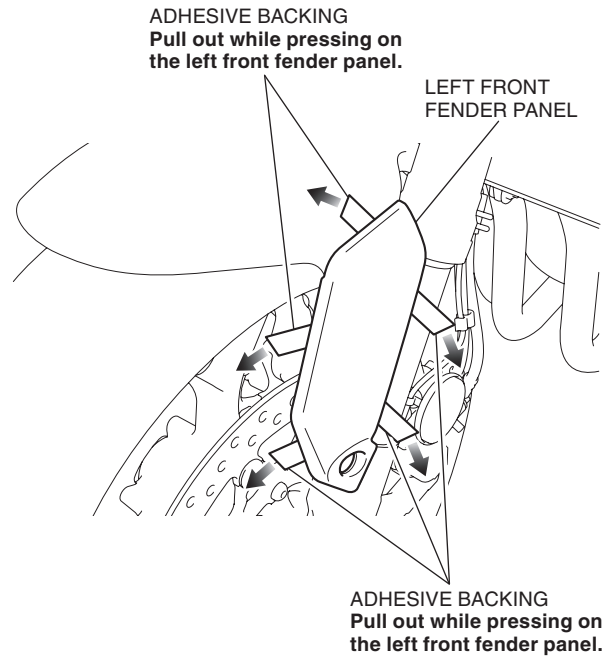

6. Apply adequate pressure to left front fender panel.
7. Install the parts as shown.

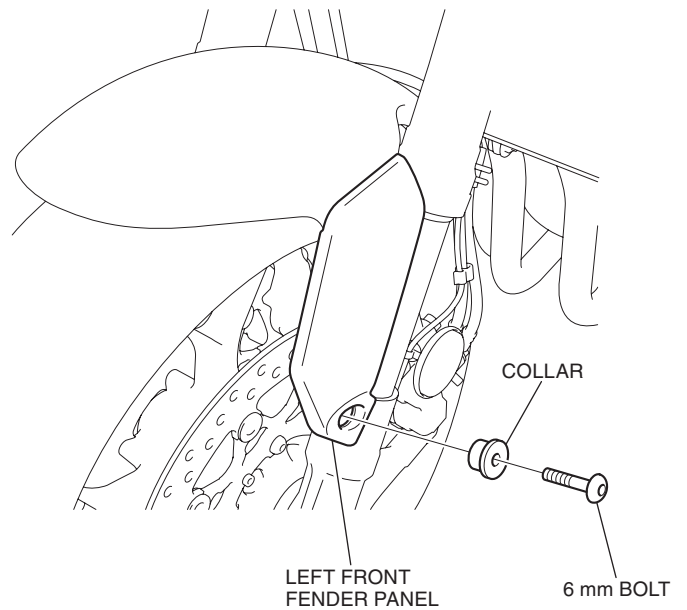

8. Install the right front fender panel in the same manner as the left side.